

# VPP6N0-S NX OOB MK.2

## OOB Connection via Wifi / 4G / RJ45

YUAN  
Visualize Intelligent Planet

### Features

- Powered by NVIDIA® Jetson Orin™ NX up to 100 / 70 TOPS
- OOB Connection via Wifi / 4G / RJ45
- 3×M.2 M Key, Gen 4×4 / Gen 4×2 / Gen 4×1
- Fanless Design
- 4×USB3.2 Gen2
- RS232 / RS485 / I2C



AIIXON



### Specifications

System		
CPU	NVIDIA Jetson Orin™ NX 8GB 6-Core Arm® Cortex®-A78AE v8.2 64-Bit CPU 1.5MB L2 + 4MB L3	NVIDIA Jetson Orin™ NX 16GB 8-Core Arm® Cortex®-A78AE v8.2 64-Bit CPU 2MB L2 + 4MB L3
GPU	1024-Core NVIDIA Ampere Architecture GPU with 32 Tensor Cores	
AI Performance	NVIDIA Jetson Orin™ NX 8GB 70 TOPS	NVIDIA Jetson Orin™ NX 16GB 100 TOPS
System Memory	NVIDIA Jetson Orin™ NX 8GB 8GB LPDDR5	NVIDIA Jetson Orin™ NX 16GB 16GB LPDDR5
Interface		
Storage	Supports External NVMe	
Display Interface	2×HDMI2.0	
Ethernet	1×RJ45 for 10/100/1000 Mbps Ethernet DHCP Client	
Expansion Slot	M.2 1×M.2 2280/3080 M Key PCIe Gen4×4 Slot 1×M.2 2280 M Key PCIe Gen4×2 Slot 1×M.2 2280 M Key PCIe Gen4×1 Slot 1×M.2 3042/3052 M Key USB3.2 Gen1 Slot ( On Optional 5G Daughter Board )	
USB	4×USB3.2 Gen2 ( Type-A )	
MIPI	2×4MIPI CSI-2 Lanes ( D-PHY 2.1, Support MIPI Camera, Capture Card )	
Audio	1×Line In ( 3.5mm or Pin Header ) 1×Line Out ( 3.5mm or Pin Header )	
Perherial Communication	1×RS232 ( Phoenix Connector or Pin Header ) 1×RS485 ( Phoenix Connector or Pin Header ) 4×GPIO ( Pin Header ) 3×I2C ( Pin Header )	
Misc. Features	Firmware Upgradable AutoPower ( Pin Header )	

### OOB Specifications

Out-Of-Band Management Functions	
Allxon swiftDR for Power Cycling	Edge Device Force Shutdown Edge Device Power Switch ON/OFF Edge Device Power ON/OFF Detection Edge Device Reset
Extension I/O	1x USB 2.0 1x I2C 1x UART 2x GPIO 1x 3.3Vdc
Out-Of-Band Management Network Interface	
Ethernet	1-port 10/100 Mbps RJ45 Port
Wireless	Support 4G LTE Module with SIM Card Slot & Wi-Fi USB Dongle

#### Remote Management Enrollment

VPP6N0-S NX OOB MK.2 supports Allxon's remote edge AI device management solutions to assist users in overcoming the challenges encountered during the AI/IoT projects. To get started with Allxon's various solutions, follow the instructions with the web page below to activate different Allxon services according to your needs.



OOB Management  
Introduction



Getting Start with  
Remote Management

## Add-On Cards / SDK / Software

Video Feature				
	Model	Interface	Max. Resolution	Capture / Preview
Capture Card ( Optional )	SC750N1 M2 HDMI2.1	1×HDMI2.1	4096×2160p@60/50fps ( 4:4:4 / 10Bit )	4:2:2 10Bit P210 4:2:0 10Bit P010 4:4:4 8Bit YV24 4:4:4 8Bit RGB32 / 24 4:2:2 8Bit YUY2 4:2:0 8Bit YV12, NV12
	SC710N1 M2 HDMI2.0	1×HDMI2.0	4096×2160p@60/50fps	
	SC710N1 M2 12G-SDI	1×12G-SDI, 1×Quad-Link 3G-SDI	4096×2160p@60/50fps	
	SC400N4 M2 TVI / AHD	4×TVI / AHD	1920×1080p@30/25fps	
	SC400N4 M2 HDMI	4×HDMI	1920×1080p@60/50fps	
	SC400N4 M2 SDI	4×3G-SDI	1920×1080p@60/50fps	
	SC400N1 M2 HDV	1×DVI-I, 1×YPbPr, 1×VGA	1920×1080p@60/50fps	
Video Encode	AV1 ( UHP ) 1×4K60   3×4K30   6×1080p60   12×1080p30			
	H.265 ( UHP ) 1×4K60   3×4K30   6×1080p60   12×1080p30			
	H.264 ( UHP ) 1×4K60   2×4K30   5×1080p60   11×1080p30			
Video Decode	AV1 ( Main Profile ) 1×8K30   2×4K60   4×4K30   9×1080p60   20×1080p30			
	H.265 ( Main, Main10 ) 1×8K30   2×4K60   4×4K30   9×1080p60   18×1080p30			
	H.264 ( Baseline, Main, High ) 1×4K60   2×4K30   5×1080p60   11×1080p30			
	VP9 ( Profile 0, Profile 2 ) 1×4K60   3×4K30   7×1080p60   15×1080p30			
SDK				
QCAP	Capture High Performance Renderer Image Snapshot Deinterlace, Alpha Blending Engine Auto Signal Detection 2D/3D Video, Audio and VANC Streams Capture			
	Record Encrypt / Sync / Clone / Recording Time-Shifting / Rewind / Pre-Event / Recording Multi-Streams ( 3D ) Recording Animation Transition Effect Video Cropping, Scaling and Alpha Blending Engine			
	Stream 2D/3D Universal Stream Client 2D/3D Multi-Streams Stream Server RTSP, RTMP, HLS, SRT, TS, WebRTC., Full NDI (*), NDI-HX (*), Dante AV-H (*) Animation Transition Effect Video Cropping, Scaling and Alpha Blending Engine <b>*Separate License Required</b>			
QDEEP	AI SDK Integrated Multiple Algorithms and Deep-Learning Models in Various Fields of Applications Face Recognition Objects Detection Objects Segment Optical Character Recognition License Plate Recognition Customizable Video AI Functions Upon Request			



SC750N1 M2 HDMI2.1

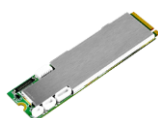

SC710N1 M2 HDMI2.0

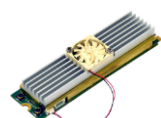

SC710N1 M2 12G-SDI



SC400N4 M2 TVI / AHD

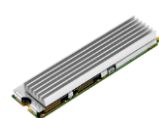

SC400N4 M2 HDMI



SC400N4 M2 SDI



SC400N1 M2 HDV

Software ( Optional )		
Stream Catcher Pro	Capture Auto Signal Detection Deinterlace, OSD, Color Adjustment Image Snapshot Animation Transform Effect for PGM	
	Record AV1, H.26X MP4, TS Multi-Stream Recording Schedule Recording	
	Stream Multi-Streams Stream Server RTSP, RTMP, HLS, SRT, TS, WebRTC., Full NDI (*), NDI-HX (*), Dante AV-H (*) <b>*Separate License Required</b>	
Xtremer	Web Based User Interface	
	Encode / Decode AV1, H.26X	
	Color Format Adjust 444 / 422 / 420, 10Bit / 8Bit Select	
	Record MP4, TS	
	Stream / Network RTSP, RTMP, HLS, SRT, TS, WebRTC., Full NDI (*), NDI-HX (*), Dante AV-H (*) <b>*Separate License Required</b>	

## Environment

Development Environment	
OS	Ubuntu: 20.04
Kernel	5.10.104-tegra or Higher
BSP	Linux for Tegra(L4T) R35.3.1 or Higher
SDK	JetPack 5.1.1 or Higher
Environment	
Power Supply	DC input : 19V
Power Consumption	TBA
Operating Temperature	Standard Version: 0~60 °C with Airflow
Storage Temperature	-20~80 °C

## Mechanical

- Dimension of case: 144mm×98mm×102.2mm
- Dimension of main Board: 140mm×90mm
- Weight: TBA

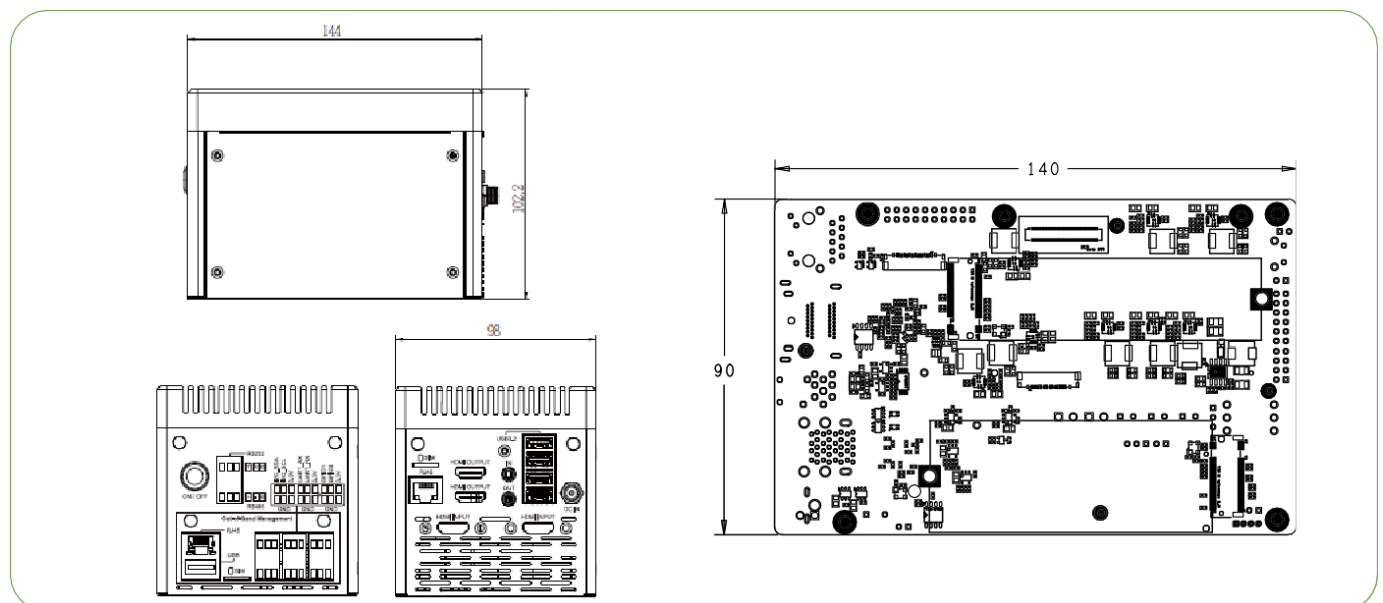

# I/O Layout

## • Case

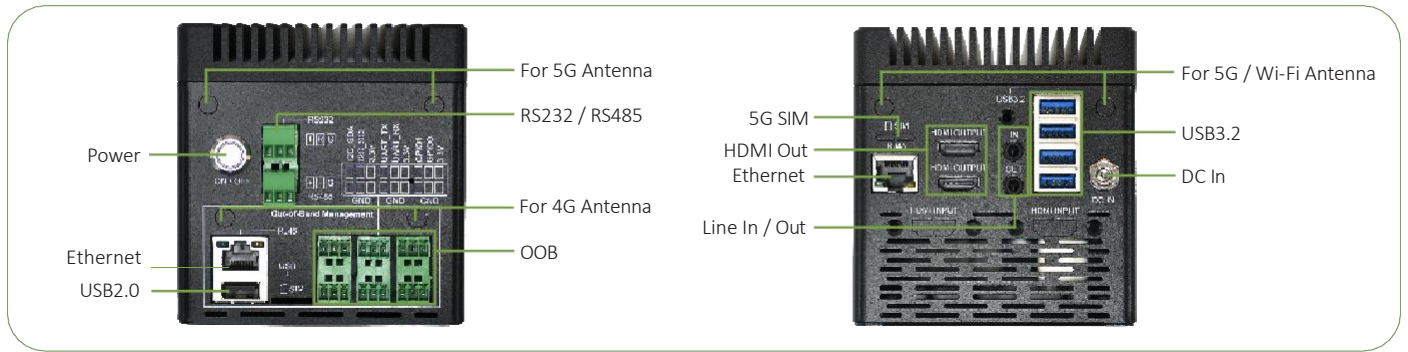

## • Carrier Board

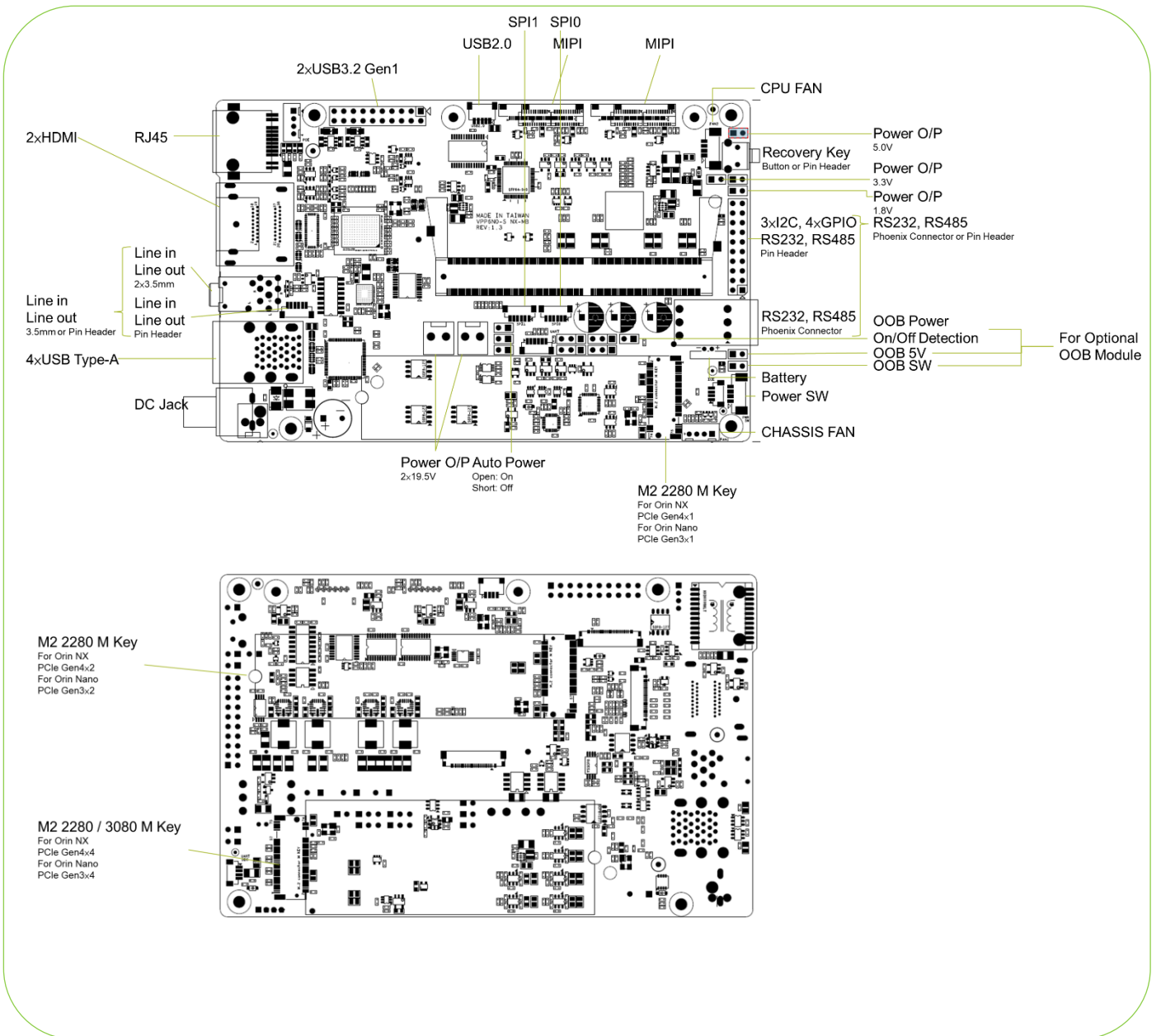

• OOB Daughter Board

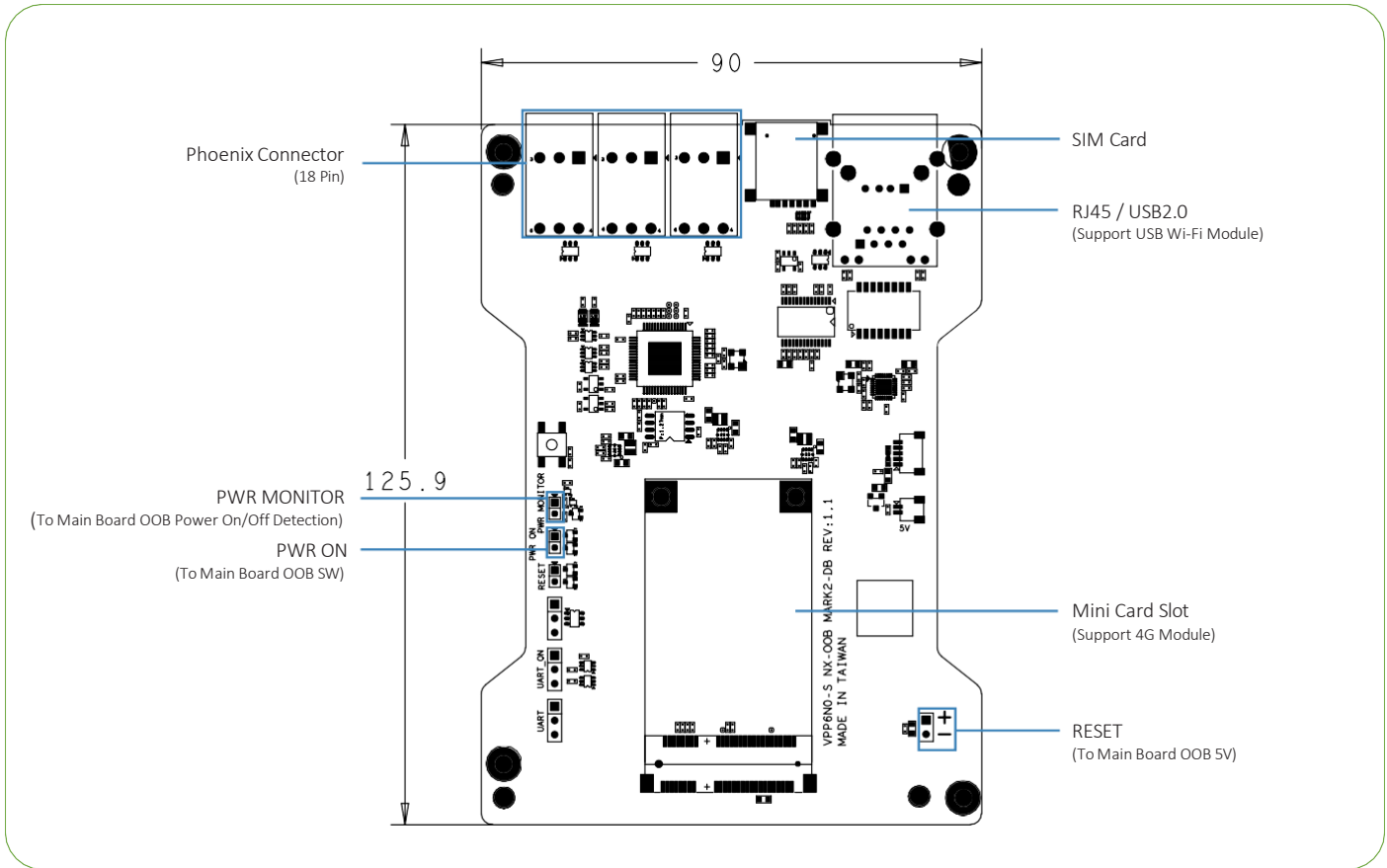

• 5G Daughter Board

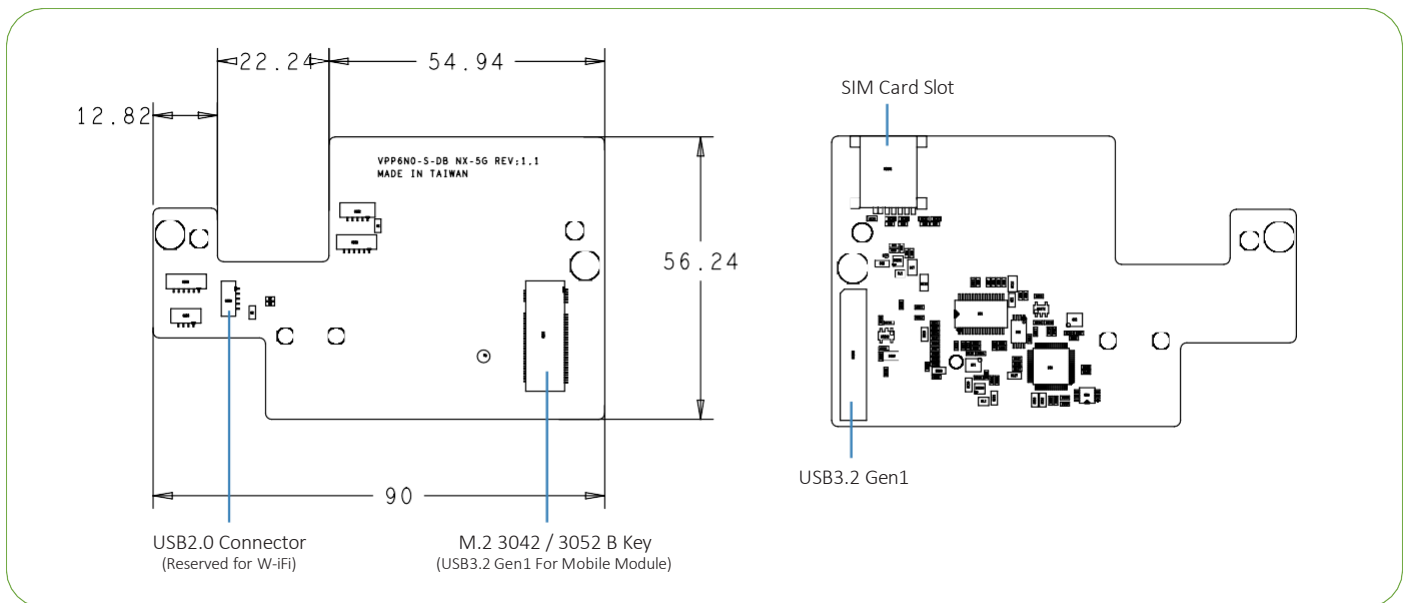

\* All registered trademarks are the property of their owners. The photo is for reference only.

\* Technology License Patent Royalty. Supplier ( YUAN Technology Ltd. ) as an OEM vendor is not responsible for any royalties applied to the Models and collected by any patent or trade mark holders or his exclusive, non-exclusive.

Licensees or representatives such as MPEGLA, Dolby, Thomson, Sisvel, H.264, MPEG4 and any other natural or legal person. All concerning royalties of patents and trade marks will be paid or negotiated with the above mentioned owner by you. In case of any patent or trademark infringement you are responsible for all necessary processes and costs. You accept and acknowledge that all prices of Models offered by supplier are exclusive of any royalties, charges or license fees for any patents in any countries or areas.

