

# VPP6T0 i7E

Highly Integrated Capture Platform, Provide 32 TOPS and Video Expandability

YUAN  
Visualize Intelligent Planet

## Features

- Up to 32 TOPS AI Performance
- 2×PCIe Gen3×4 for Video Expansion
- 2×M2 M Key / 1×M2 E Key / 1×M2 B Key
- 2×USB3.0 / 2×USB2.0
- 6×COM Port / 2×I2C



## Specifications

System	
CPU	Intel® Core™ i7 1165G7
GPU	Intel® Iris® Xe Graphics
AI Performance	32 TOPS
System Memory	2×16GB DDR4 3200MHz Dual Channel
Interface	
Storage	128GB M2 2280 SATA SSD 1×SATA
Display Interface	Rear Display 2×HDMI2.0  Internal Display 1×HDMI2.0 ( Onboard Connector ) 1×eDP ( Onboard Connector )
Ethernet	2×RJ45 for 10/100/1000Mbps Ethernet DHCP Client
Expansion Slot	PCIe 1×PCIe Gen3×4 Slot 1×PCIe Gen3×4 Slot ( Switch with M.2 M Key)  M2 1×M2 2280 M Key PCIe Gen3×4 Slot ( Switch with 2nd PCIe ) 1×M2 3042 B Key USB3.0 Slot with SIM Card Slot 1×M2 2230 E Key PCIe Gen3×1/USB2.0 Slot
USB	Front USB 1×USB3.0 ( Type-A )  Rear USB 1×USB3.0 ( Type-A ) 2×USB2.0 ( Type-A )  Internal USB 4×USB2.0 ( Pin Header )
Audio	1×3.5mm Line/MIC In 1×3.5mm Line Out
Perherial Communication	6×COM Port ( Pin Header ) 2×I2C ( Pin Header )
Misc. Features	With Option Front Panel Control Button ( Compatible with Stream Capture Pro )

# Add-On Cards / SDK / Software

Video Feature				
Capture Card ( Optional )	PCIe Model	Interface	Max. Resolution	Capture / Preview 4:2:2 10Bit P210 4:2:0 10Bit P010 4:4:4 8Bit YV24 4:4:4 8Bit RGB32 / 24 4:2:2 8Bit YUY2 4:2:0 8Bit YV12, NV12
	SC750N1T HDMI2.1	1×HDMI2.1	7680×4320p@60/50fps	
	SC710N4T HDMI2.0	4×HDMI2.0	4096×2160p@60/50fps	
	SC710N4T 12G-SDI	4×12G-SDI	4096×2160p@60/50fps	
	SC420N16 TVI / AHD	16×TVI / AHD	1920×1080p@30/25fps	
	SC420N8 GMSL2	8×GMSL2	1920×1080p@60/45/30fps	
	SC410N4 HDMI	4×HDMI	4096×2160p@30/25fps	
	SC410N4 6G-SDI	4×6G-SDI	4096×2160p@30/25fps	
	M2 Model	Interface	Max. Resolution	
	SC710N1 M2 HDMI2.0	1×HDMI2.0	4096×2160p@60/50fps	
	SC710N1 M2 12G-SDI	1×12G-SDI	4096×2160p@60/50fps	
	SC400N1 M2 HDV	1×DVI-I, 1×YPbPr, 1×VGA	1920×1080p@60/50fps	
Video Encode	H.265 ( HEVC ) 1×8K60   4×4K60   8×4K30   16×1080p60   32×1080p30			
	H.264 3×4K60   6×4K30   12×1080p60   24×1080p30			
Video Decode	H.265 ( HEVC ) 4×4K60   8×4K30   16×1080p60   32×1080p30			
	H.264 3×4K60   6×4K30   12×1080p60   24×1080p30			
SDK				
QCAP	Capture High Performance Renderer Image Snapshot Deinterlace, Alpha Blending Engine Auto Signal Detection 2D/3D Video, Audio and VANC Streams Capture			
	Record Encrypt / Sync / Clone / Recording Time-Shifting / Rewind / Pre-Event / Recording Multi-Streams ( 3D ) Recording Animation Transition Effect Video Cropping, Scaling and Alpha Blending Engine			
	Stream 2D/3D Universal Stream Client 2D/3D Multi-Streams Stream Server RTSP, RTMP, HLS, SRT, TS, WebRTC. NDI-HX (*), Dante AV-H (*) Animation Transition Effect Video Cropping, Scaling and Alpha Blending Engine <b>*Separate License Required</b>			
QDEEP	AI SDK Integrated Multiple Algorithms and Deep-Learning Models in Various Fields of Applications Face Recognition Objects Detection Objects Segment Optical Character Recognition License Plate Recognition Customizable Video AI Functions Upon Request			



SC750N1T HDMI2.1



SC710N4T HDMI2.0



SC710N4T 12G-SDI

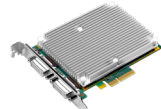

SC420N16 TVI / AHD



SC420N8 GMSL2



SC410N4 HDMI

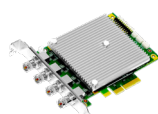

SC410N4 6G-SDI



SC710N1 M2 HDMI2.0

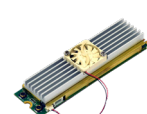

SC710N1 M2 12G-SDI



SC400N1 M2 HDV

## Software ( Optional )

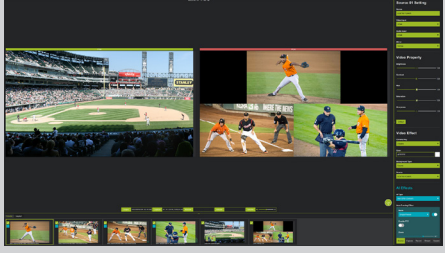
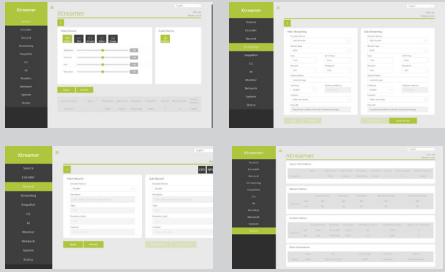
Stream Catcher Pro	Capture Auto Signal Detection Deinterlace, OSD, Color Adjustment Image Snapshot Animation Transform Effect for PGM	
	Record H.26X MP4, TS Multi-Stream Recording Schedule Recording	
	Stream Multi-Streams Stream Server RTSP, RTMP, HLS, SRT, TS, WebRTC. NDI-HX (*), Dante AV-H (*) *Separate License Required	
Xtreamer	Web Based User Interface	
	Encode / Decode H.26X	
	Color Format Adjust 444 / 422 / 420, 10Bit / 8Bit Select	
	Record MP4, TS	
	Stream / Network RTSP, RTMP, HLS, SRT, TS, WebRTC. NDI-HX (*), Dante AV-H (*) *Separate License Required	

## Environment

### Development Environment

OS	Windows 10 64Bit Ubuntu 20.04 64Bit
SDK	Windows: C++, C#, .Net VB, Java, Python, Delphi, BCB, LabVIEW Linux: C, C++, Python, Java, nodeJS, .Net

### Environment

Power Supply	DC input : 19V
Power Consumption	TBA
Operating Temperature	0~40 °C
Storage Temperature	-40~70 °C

## Mechanical

- Dimension of case: 186.5mm ( 189.8mm ) ×307.2mm×44.8mm ( 50.3mm )
- Dimension of main Board: 181.5mm×160mm
- Weight: TBA

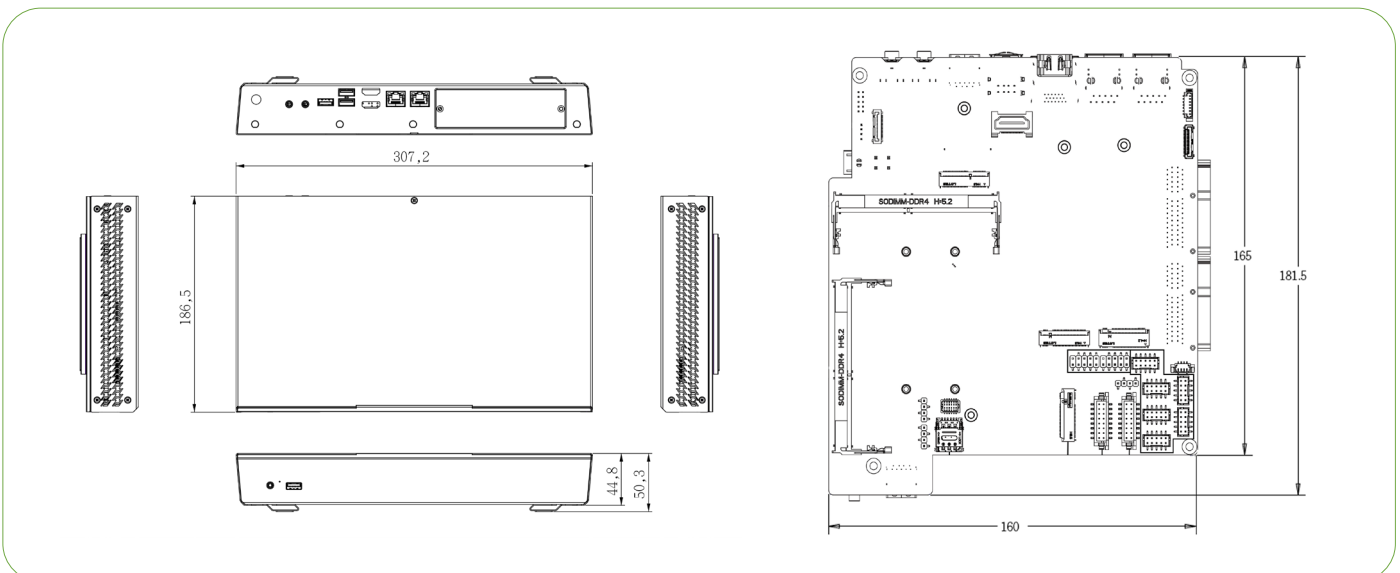

# I/O Layout

## • Case

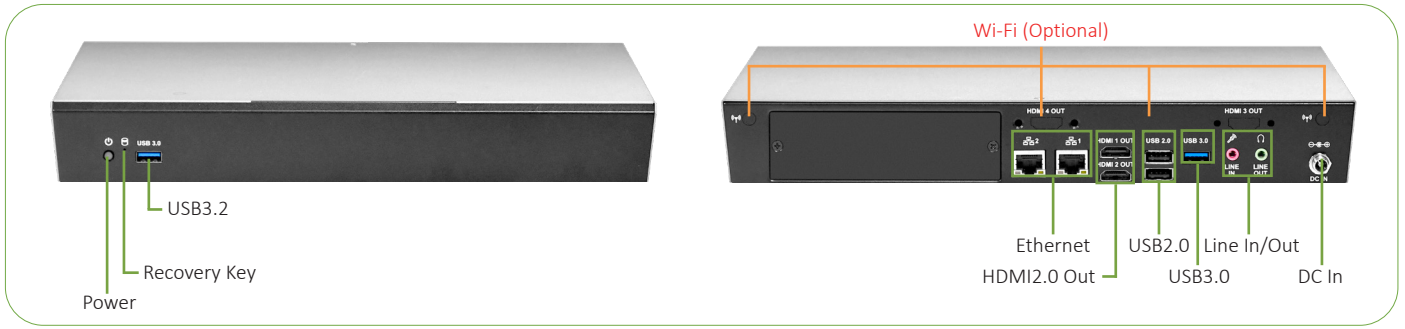

## • Carrier Board

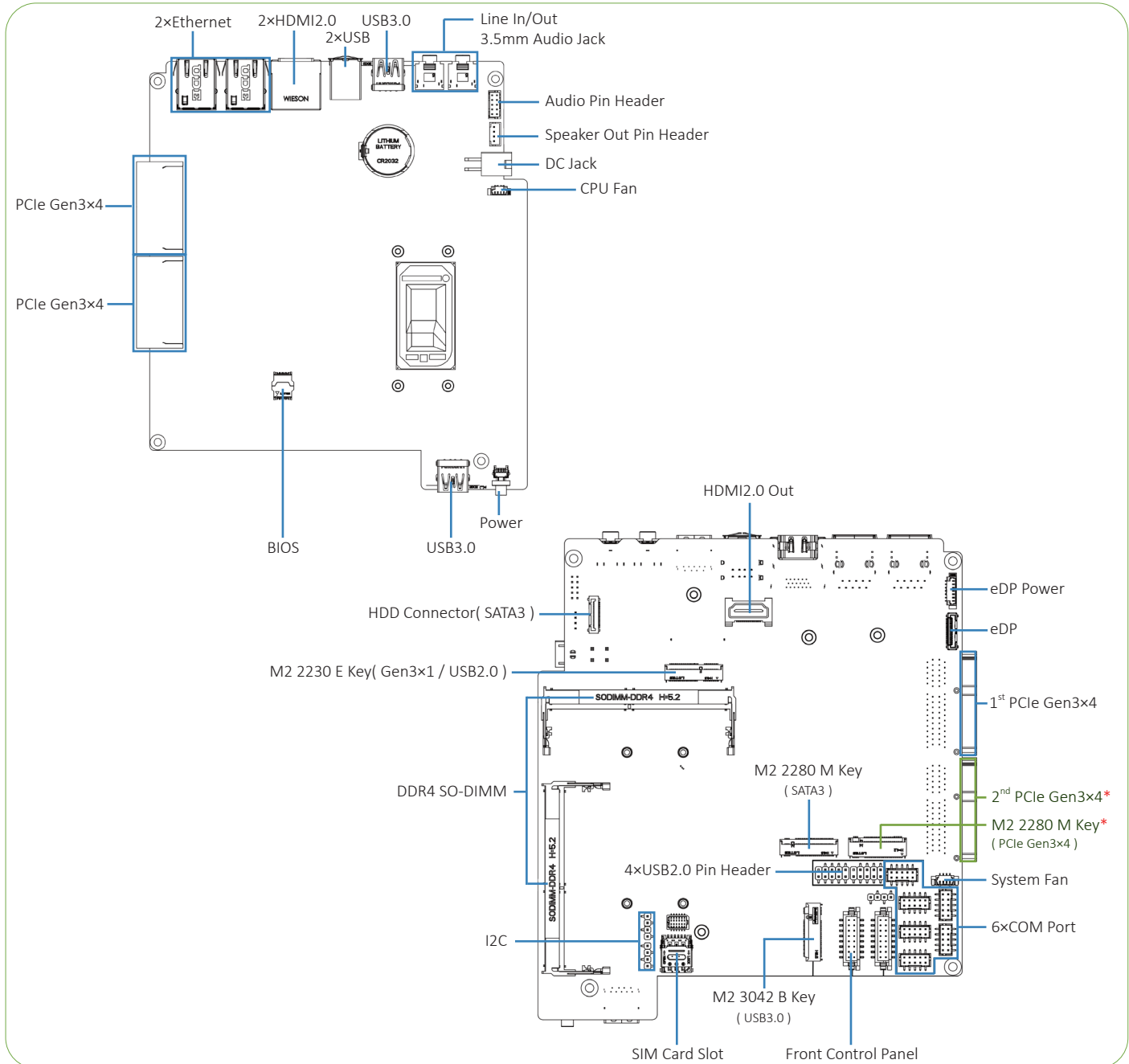

\* "2<sup>nd</sup> PCIe Gen3x4" and "M2 2280 M Key (PCIe Gen3x4)" share the same PCIe lanes.

\* All registered trademarks are the property of their owners. The photo is for reference only.

\* Technology License Patent Royalty. Supplier (YUAN Technology Ltd.) as an OEM vendor is not responsible for any royalties applied to the Models and collected by any patent or trade mark holders or his exclusive, non-exclusive.

Licensees or representatives such as MPEG4, Dolby, Thomson, Sisvel, H.264, MPEG4 and any other natural or legal person. All concerning royalties of patents and trade marks will be paid or negotiated with the above mentioned owner by you. In case of any patent or trademark infringement you are responsible for all necessary processes and costs. You accept and acknowledge that all prices of Models offered by supplier are exclusive of any royalties, charges or license fees for any patents in any countries or areas.

