

VPP6N0-S AGX

Highly Integrated AI Server, Provide 275 TOPS and Expandability

YUAN
Visualize Intelligent Planet

Features

- Powered by NVIDIA® Jetson AGX Orin™ up to 275 TOPS
- 2×PCIe Gen3×4
- 3×M.2 M Key / 1×M.2 E Key / 1×M.2 B Key
- Fanless Design
- 2×USB3.2 Gen2
- CAN Bus / UART / I2C / SPI



Specifications

System		
CPU	NVIDIA Jetson AGX Orin™ 32GB 8-core Arm® Cortex®-A78AE v8.2 64-Bit CPU 2MB L2 + 4MB L3	NVIDIA Jetson AGX Orin™ 64GB 12-Core Arm® Cortex®-A78AE v8.2 64-Bit CPU 3MB L2 + 6MB L3
GPU	NVIDIA Jetson AGX Orin™ 32GB 1792-Core NVIDIA Ampere Architecture GPU with 56 Tensor Cores	NVIDIA Jetson AGX Orin™ 64GB 2048-Core NVIDIA Ampere Architecture GPU with 64 Tensor Cores
AI Performance	NVIDIA Jetson AGX Orin™ 32GB 200 TOPS	NVIDIA Jetson AGX Orin™ 64GB 275 TOPS
System Memory	NVIDIA Jetson AGX Orin™ 32GB 32GB LPDDR5	NVIDIA Jetson AGX Orin™ 64GB 64GB LPDDR5
Interface		
Storage	64GB eMMC 5.1 (On NVIDIA Jetson AGX Orin™ Module)	
Display Interface	2×HDMI2.0 1×DP *Select 2 Video Output Port at Same Time	
Ethernet	2×RJ45 for 10/100/1000Mbps Ethernet DHCP Client	
Expansion Slot	PCIe 1×PCIe Gen3×4 Slot(*) 1×PCIe Gen3×4 Slot(**) M.2 1×M.2 2230 E Key PCIe Gen4*1/USB2.0/SDIO Slot 1×M.2 2280 M Key PCIe Gen4×4 Slot 1×M.2 2280 M Key PCIe Gen4×4 Slot(*) 1×M.2 3080 M Key PCIe Gen4×4 Slot(**) 1×M.2 3042 B Key USB3.2 Gen2 (10G) Slot * Please select either 1×PCIe Gen3×4 Slot or 1×M.2 2280 M Key PCIe Gen4×4 Slot to use ** Please select either 1×PCIe Gen3×4 Slot or 1×M.2 3080 M Key PCIe Gen4×4 Slot to use	
USB	2×USB3.2 Gen2 (Type-A) 2×USB3.2 Gen1 (Pin Header) 2×USB2.0 (Type-A)	
MIPI	16×MIPI CSI-2 Lanes (D-PHY 2.1, 4×4 3×4+2×2 2×4+4×2 1×4+5×2 6×2 MIPI Lanes, Support MIPI Camera, Capture Card)	
Audio	1×3.5mm Line In 1×3.5mm Line Out	
Perherial Communication	1×UART (Pin Header) 3×GPIO (Pin Header) 2×CAN Bus (Pin Header) 2×I2C (Pin Header) 1×I2S (Pin Header) 1×SPI (Pin Header) 3×PWM (Pin Header)	
Misc. Features	Firmware Upgradable AutoPower (Pin Header)	

Add-On Cards / SDK / Software

Video Feature				
Capture Card (Optional)	PCIe Model	Interface	Max. Resolution	Capture / Preview
	SC710N4T HDMI2.0	4xHDMI2.0	4096x2160p@60/50fps	
	SC710N4T 12G-SDI	4x12G-SDI	4096x2160p@60/50fps	
	SC420N16 TVI	16xTVI / AHD	1920x1080p@30/25fps	
	SC420N8 GMSL2	8xGMSL2	1920x1080p@60/45/30fps	
	SC410N4 HDMI	4xHDMI	4096x2160p@30/25fps	
	SC410N4 6G-SDI	4x6G-SDI	4096x2160p@30/25fps	
	M.2 Model	Interface	Max. Resolution	
	SC710N1 M2 HDMI2.0	1xHDMI2.0	4096x2160p@60/50fps	
	SC710N1 M2 12G-SDI	1x12G-SDI	4096x2160p@60/50fps	
	SC400N1 M2 HDV	1xDVI-I, 1xYPbPr, 1xVGA	1920x1080p@60/50fps	
	Video Encode	NVIDIA Jetson AGX Orin™ 32GB		
AV1 (UHP) · 1x4K60 3x4K30 6x1080p60 12x1080p30 H.265 (UHP) · 1x4K60 3x4K30 6x1080p60 12x1080p30 H.264 (UHP) · 1x4K60 2x4K30 5x1080p60 11x1080p30		AV1 (UHP) · 2x4K60 4x4K30 8x1080p60 16x1080p30 H.265 (UHP) · 2x4K60 4x4K30 8x1080p60 16x1080p30 H.264 (UHP) · 1x4K60 3x4K30 7x1080p60 14x1080p30		
Video Decode	NVIDIA Jetson AGX Orin™ 32GB		NVIDIA Jetson AGX Orin™ 64GB	
	AV1 (Main Profile) · 1x8K30 2x4K60 4x4K30 7x1080p60 15x1080p30 H.265 (Main, Main10) · 1x8K30 2x4K60 4x4K30 9x1080p60 18x1080p30 H.264 (Baseline, Main, High) · 1x4K60 2x4K30 5x1080p60 11x1080p30 VP9 (Profile 0, Profile 2) · 1x4K60 3x4K30 7x1080p60 15x1080p30		AV1 (Main Profile) · 1x8K30 3x4K60 6x4K30 9x1080p60 18x1080p30 H.265 (Main, Main10) · 1x8K30 3x4K60 7x4K30 11x1080p60 22x1080p30 H.264 (Baseline, Main, High) · 1x4K60 3x4K30 6x1080p60 13x1080p30 VP9 (Profile 0, Profile 2) · 1x8K30 3x4K60 6x4K30 9x1080p60 18x1080p30	
SDK				
QCAP	Capture High Performance Renderer Image Snapshot Deinterlace, Alpha Blending Engine Auto Signal Detection 2D/3D Video, Audio and VANC Streams Capture			
	Record Encrypt / Sync / Clone / Recording Time-Shifting / Rewind / Pre-Event / Recording Multi-Streams (3D) Recording Animation Transition Effect Video Cropping, Scaling and Alpha Blending Engine			
	Stream 2D/3D Universal Stream Client 2D/3D Multi-Streams Stream Server RTSP, RTMP, HLS, SRT, TS, WebRTC., Full NDI (*), NDI-HX (*), Dante AV-H (*) Animation Transition Effect Video Cropping, Scaling and Alpha Blending Engine *Separate License Required			
QDEEP	AI SDK Integrated Multiple Algorithms and Deep-Learning Models in Various Fields of Applications Access Control Objects Detection Objects Segment Optical Character Recognition License Plate Recognition Customizable Video AI Functions Upon Request			



SC710N4T HDMI2.0



SC710N4T 12G-SDI

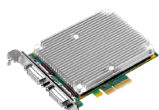

SC420N16 TVI / AHD



SC420N8 GMSL2



SC410N4 HDMI

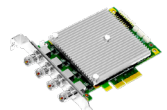

SC410N4 6G-SDI



SC710N1 M2 HDMI2.0

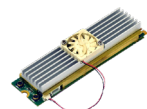

SC710N1 M2 12G-SDI



SC400N4 M2 TVI/AHD



SC400N4 M2 HDMI

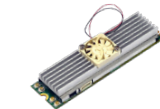

SC400N4 M2 SDI

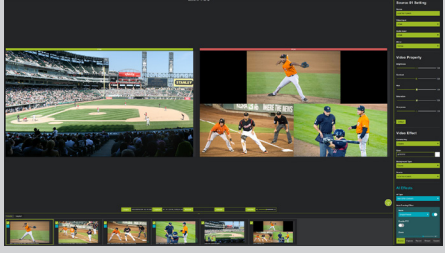
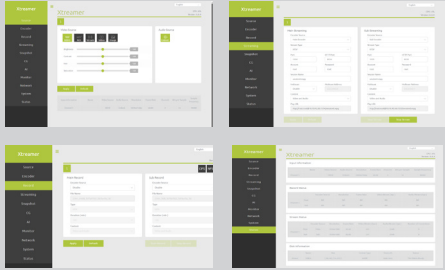

SC400N1 M2 HDV

Software (Optional)		
Stream Catcher Pro	Capture Auto Signal Detection Deinterlace, OSD, Color Adjustment Image Snapshot Animation Transform Effect for PGM	
	Record AV1, H.26X MP4, TS Multi-Stream Recording Schedule Recording	
	Stream Multi-Streams Stream Server RTSP, RTMP, HLS, SRT, TS, WebRTC., Full NDI (*), NDI-HX (*), Dante AV-H (*) *Separate License Required	
Xtreamer	Web Based User Interface	
	Encode / Decode AV1, H.26X	
	Color Format Adjust 444 / 422 / 420, 10Bit / 8Bit Select	
	Record MP4, TS	
	Stream / Network RTSP, RTMP, HLS, SRT, TS, WebRTC., Full NDI (*), NDI-HX (*), Dante AV-H (*) *Separate License Required	

Environment

Development Environment	
OS	Ubuntu: 20.04
Kernel	5.10.104-tegra or Higher
BSP	Linux for Tegra(L4T) R35.1 or Higher
SDK	JetPack 5.0.2 or Higher
Environment	
Power Supply	DC input : 19V
Power Consumption	TBA
Operating Temperature	Standard Version: 0~60 ° C with Airflow
Storage Temperature	-20~80 ° C

Mechanical

- Dimension of case: 266.58mm×188.20mm×105.29mm
- Dimension of main Board: 181.5mm×167mm
- Weight: TBA

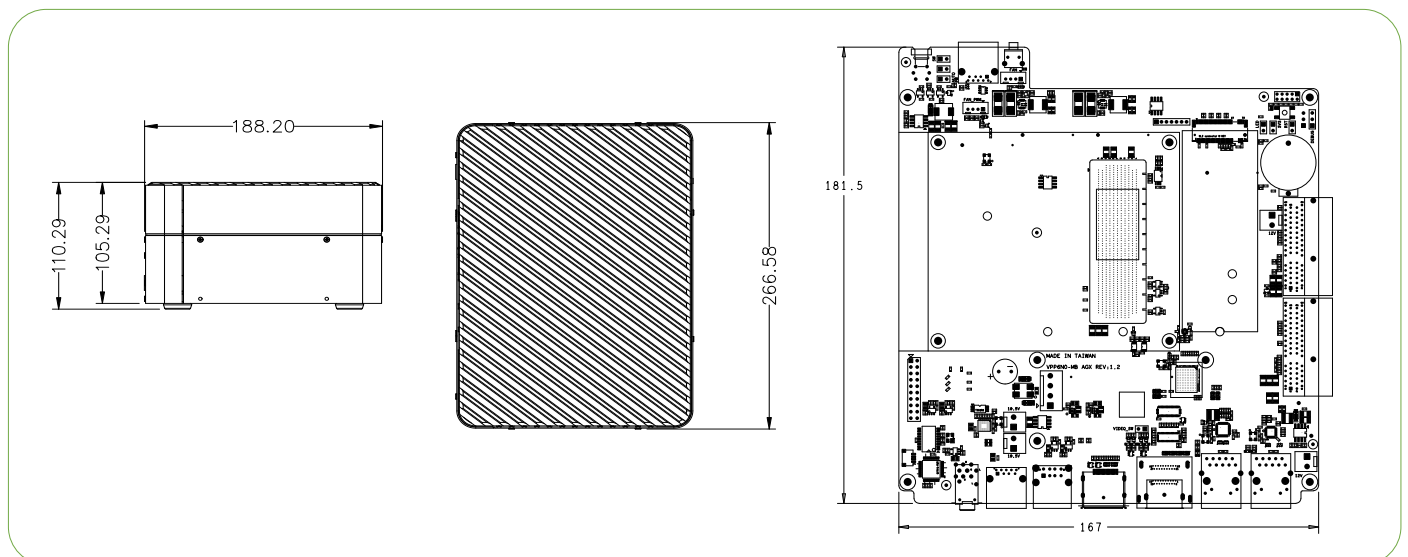

I/O Layout

• Case

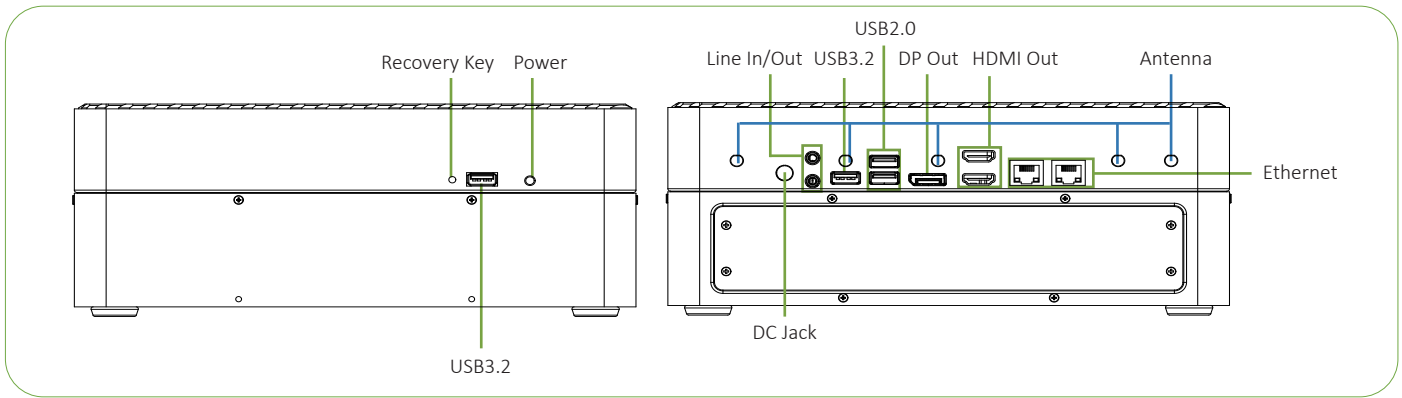

• Carrier Board

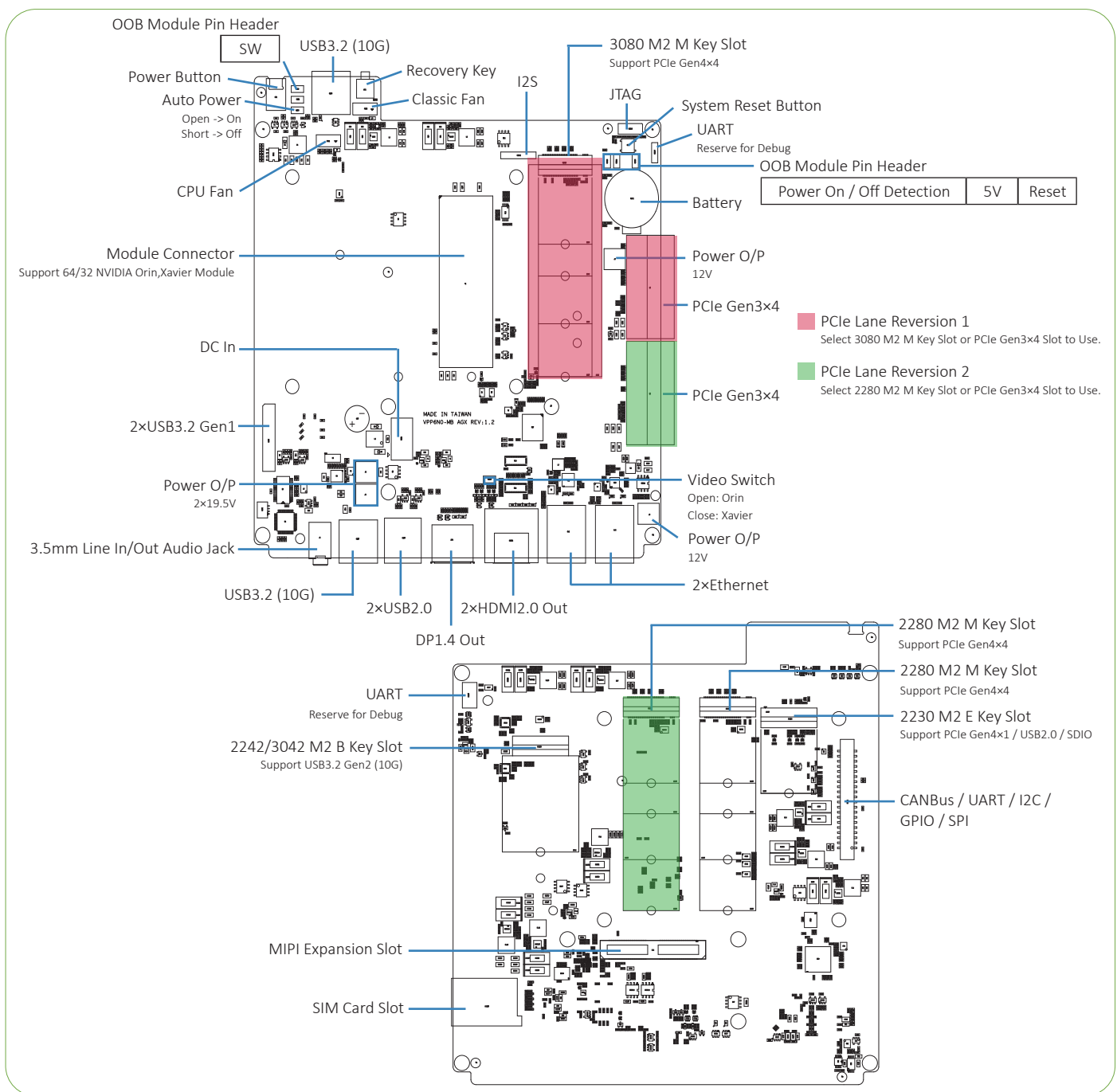

* All registered trademarks are the property of their owners. The photo is for reference only.

* Technology License Patent Royalty. Supplier (YUAN Technology Ltd.) as an OEM vendor is not responsible for any royalties applied to the Models and collected by any patent or trade mark holders or his exclusive, non-exclusive.

Licensees or representatives such as MPEG4, Dolby, Thomson, Sisvel, H.264, MPEG4 and any other natural or legal person. All concerning royalties of patents and trade marks will be paid or negotiated with the above mentioned owner by you. In case of any patent or trademark infringement you are responsible for all necessary processes and costs. You accept and acknowledge that all prices of Models offered by supplier are exclusive of any royalties, charges or license fees for any patents in any countries or areas.

